



www.hospitalystems.com

Installation Instructions

Tel: 925.427.7800
Fax: 925.427.0800

support@hospitalystems.com

Hospital Systems Inc.
750 Garcia Avenue
Pittsburg CA 94565
USA

PCA

Patient Service Console

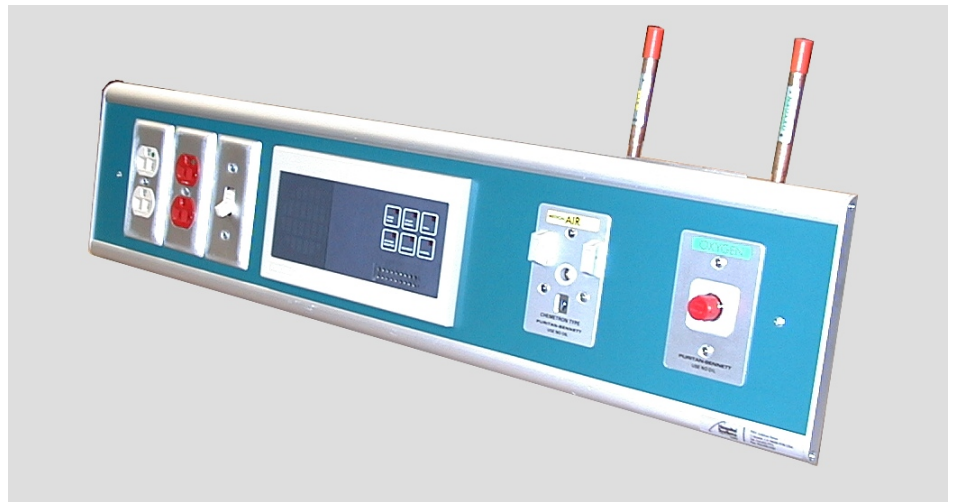

Introduction:

The Hospital Systems, Inc. PCA Patient Service Console is made to order for this project. Each console consists of a Backbox, Finish Fascia and components that are particular to each location or type. The backbox and fascia for each type of console is NOT interchangeable with another type.

Before attempting to install, please read and understand all of the instructions. In particular please refer to the final approved submittal drawings as they will take precedence over these instructions.

Basic Steps for Installing the PCA Patient Service Console

- Prepare stud wall to accommodate backbox
- Mount backbox in stud cavity
- Mount and connect medical gas outlet rough-in and test joints for leaks
- Connect all electrical and communication conduits
- Install drywall and finish building wall
- Pull in all electrical wires and communication cables
- Mount finish fascia
- Install all electrical and communication devices
- Install latch plates for all medical gas outlets
- Test and clean



Do NOT use powered screwdrivers on devices or coverplates. Stripped holes are NOT covered by warranty

Preparation of the stud wall

Determine the height and centerline for the patient console from the contract drawings. Mount a lower track $2\frac{1}{2}$ " (65 mm) below the centerline of the console. Allow vertical opening of $5\frac{1}{2}$ " [$+ \frac{1}{4}$ "-0] (135 mm). Note that upper track must be punched for medical gas piping and electrical conduits. For horizontal opening please see dimensions on approved submittal drawings. See Figure 1 for detail.

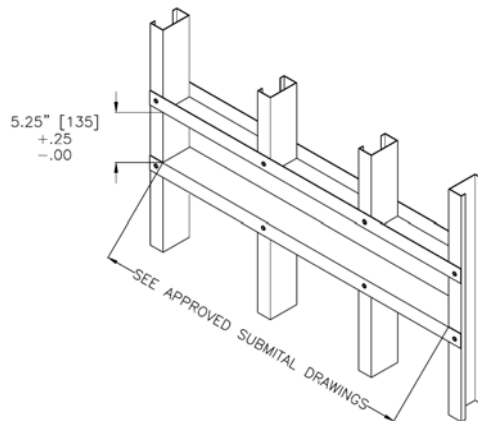

Figure 1

Mounting of the backbox

The backbox has all internal barriers already installed. Be sure to note the number in the backbox matches the location. Backboxes are left or right handed and the correct backbox must be used.

Use self-drilling screws (not provided) to attach the upper and lower mounting flange to the upper and lower tracks respectively. It is suggested that the first screw be in the lower left, check that the box is level, and add the second screw in the upper right. The rest of the screws can now be inserted on a 8-12 inch spacing. See Figure 2 for detail.

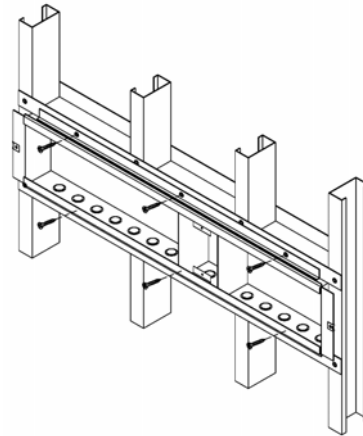

Figure 2

The flange at each end of the box will be on top of the dry-wall.
Caution: do not screw through the studs or tracks into the backbox.

Mounting the Medical Gas Outlet rough-in

Remove the knock-out in the top of the backbox at the location where the gas outlet will be installed. Refer to the approved shop drawings for correct locations. Slide the copper tube through the knock-out and the hole in the upper track and mount the MedGas Outlet with two screws (6-23. round head, Phillips, Type F, #280409 provided) to the mounting rail on the inside of the backbox. See Figure 3 for detail. Keep the plastic cap on the copper tube until it is ready to be attached to the building piping. All brazing must be completed according the NFPA 99 and local codes.

Test all medical gas lines and brazed joints according to NFPA 99 and local codes.



The inert gas (i.e. N₂, CO₂), used in brazing, must not overheat the gas outlet. (Suggestion - have inert gas flow through and away from the outlet.) Damage to the outlet due to overheating is NOT covered by warranty.



Cover the medgas outlet front with tape to keep it clean. We suggest using 2 in wide blue painter's tape.

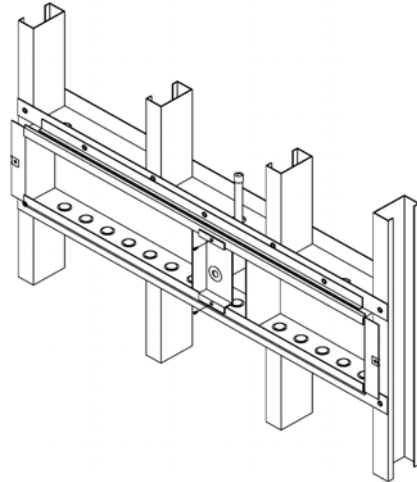

Figure 3

Special Note for Chemetron Outlets: You may have to remove the side plate if outlet is near an internal barrier or backbox end, as there may be interference with the barrier or backbox end. To remove the side plate, bend the two small tabs and remove the plate. See Figure 4.

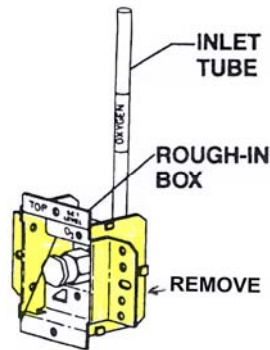

Figure 4

Electrical and Communication Conduit

Punch out knock-outs and install electrical and communication/data conduits according to the approved submittal drawings. It is not necessary to pull wire or cable at this time.

Drywall and Wall Finishes

Dry-wall contractor will now install drywall. The drywall is to go behind the end flanges of the console backbox. This will leave the threaded tinnerman clip exposed. The drywall will cover the upper and lower mounting flange and butt the upper and lower edge of the backbox.

Please remind the drywall contractor to avoid getting mud on the medgas outlet and to remove all debris from inside the box.

Electrical and Communication Wiring and Cables

Once the wall finish has been applied, the wire and cable can be pulled in. Any splicing for multiple receptacles on the same circuit should be made at this time.

Installing the Finish Fascia

Attach the finish fascia over the front of the console backbox with the screws provided [one on each end] [6-32, oval-head, Phillips, M/S #280077, provided]. See Figure 5 for details.

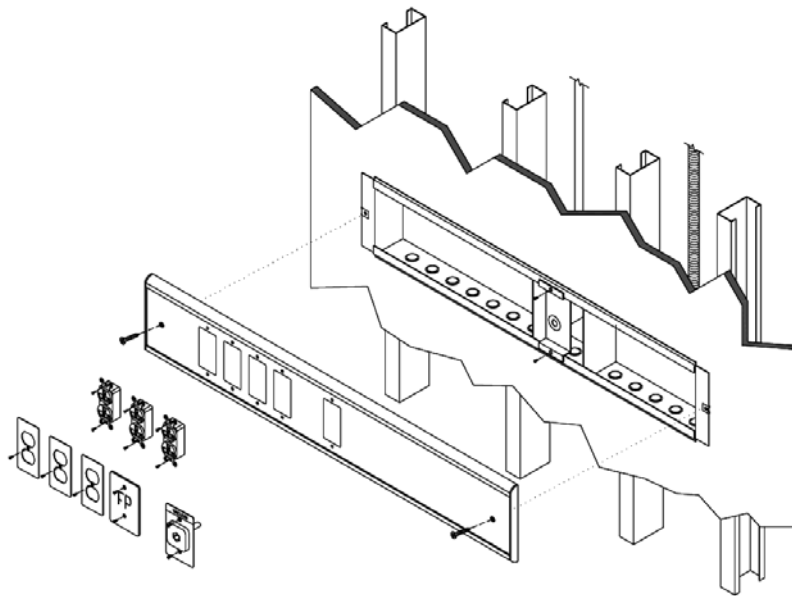

Figure 5

Electrical Devices

Wire and install the electrical devices. Screws are provided. Electrical devices are mounted directly to the Finish Fascia. Attached the coverplate with screws provided [6-32 oval-head, Phillips, M/S, #280013 provided].

Medical Gas Outlet, Latching Plate

Remove the tape over the Medgas rough-in and insert the barrel of the Medgas latching plate [front body] into the rough-in, and tighten screws until the plate is against the finish fascia.



Do not over-tighten screws



DO NOT USE POWERED SCREWDRIVER FOR THIS OPERATION

Special instruction for Chemetron outlets: Remove the tape and test plug from Medgas rough-in and screw in the primary check valve. Slide the latching plate over the primary check valve. The primary check valve must be adjusted so that the latching plate will fit snug to the Finish Fascia. Once adjustment has been made, attach the latching plate with the two stainless steel screws provided with the outlet.

Nurse Call and Other Communication Devices

Install devices per the installation instructions of the device manufacturer. Mounting holes are drilled and tapped for 6-32 screws.

Note: for telephone and/or data jacks, we have provided a module holder and coverplate. These holders will accommodate standard RJ-11, and RJ-45 modules. DO NOT INSTALL standard wall box plates. Additional holders and cover plates as well as modules (in various colors, and blanks) are available from Hospital Systems.

Final Test

Medgas outlets: complete the testing as per NFPA-99.

Electrical devices: test electrical receptacles and other devices per local code and general practices.

Cleaning

Use a soft cloth with non-abrasive cleaner (i.e. 409 or Windex) to remove dirt and fingerprints.